

MONOBLOCCO A-B LATERALI 1/2" BSP, P-T 3/4" BSP
MONOBLOCK A-B ON SIDE 1/2" BSP, P-T 3/4" BSP

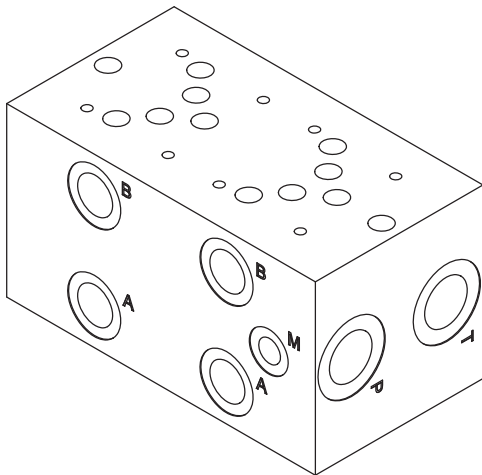

Schema idraulico
Hydraulic diagram

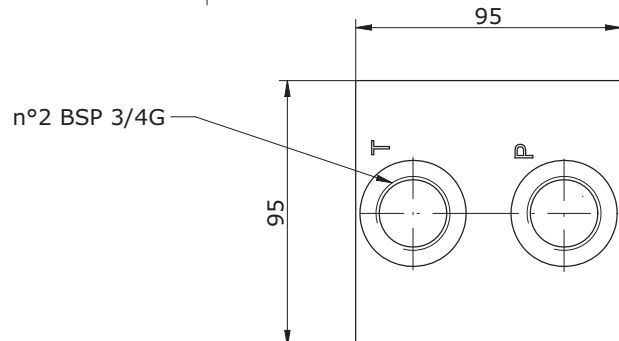
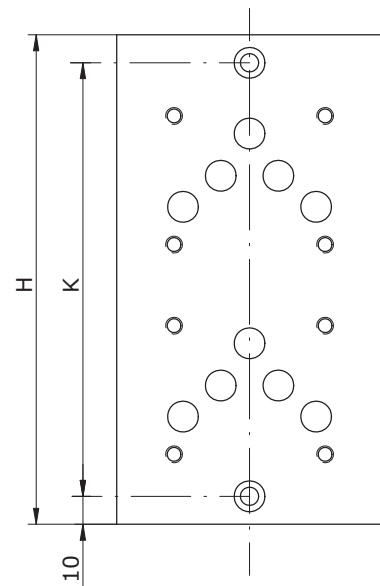
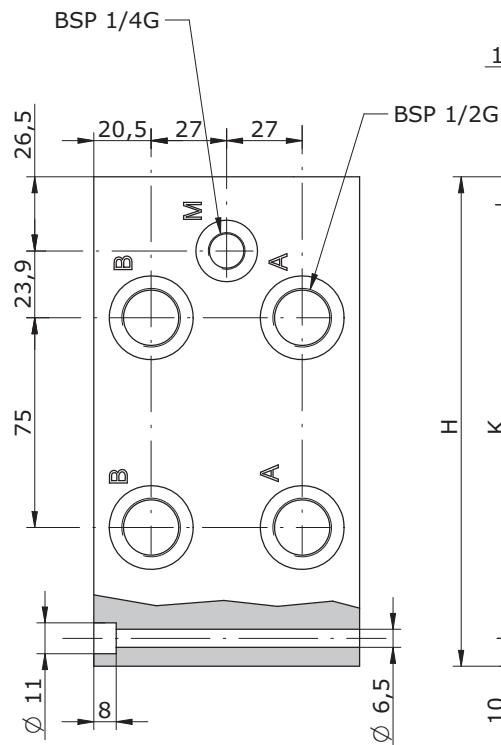
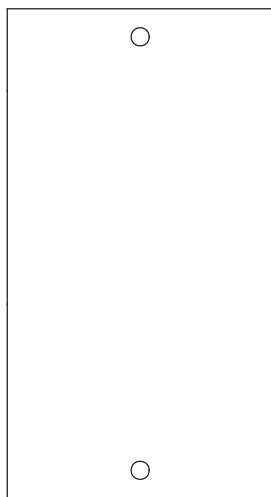
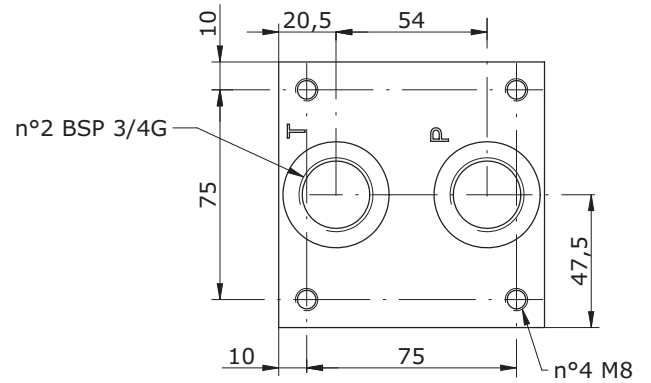
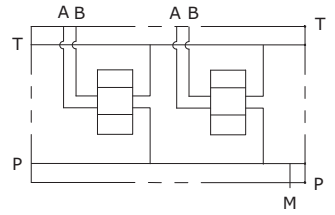

E_ 10 - 06 - 12 - ___ - 0

POS.	01	02	03	04	05	06
H	100	175	250	325	400	475
K	84	159	234	309	384	459

**MONOBLOCCO A-B LATERALI 1/2" BSP, P-T 3/4" BSP
MONOBLOCK A-B ON SIDE 1/2" BSP, P-T 3/4" BSP**



E_10 - 06 - 12 - __ - 1

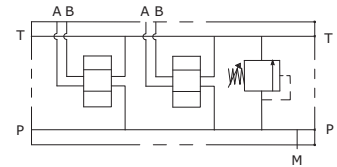
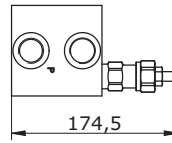
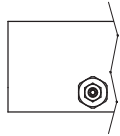
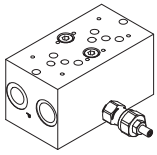

E_10 - 06 - 12 - __ - 2

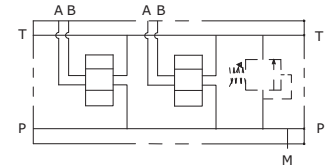
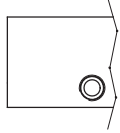
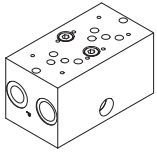

E_10 - 06 - 12 - __ - 3

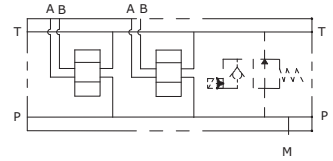
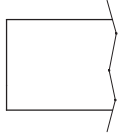
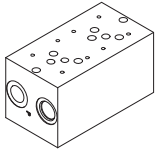

E_10 - 06 - 12 - __ - 4

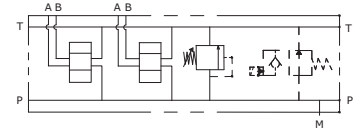
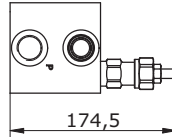
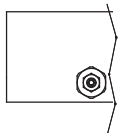
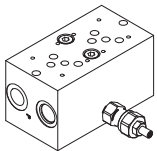

E_10 - 06 - 12 - __ - 5

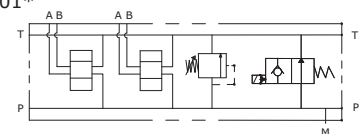
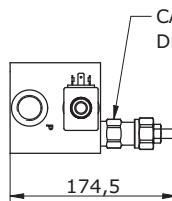
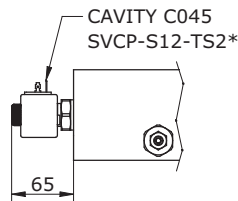
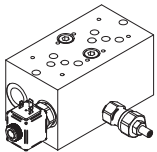

E_10 - 06 - 12 - __ - 6

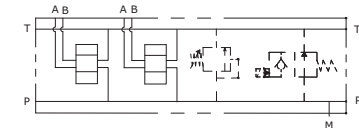
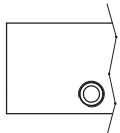
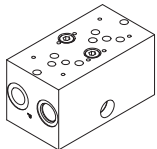

E_10 - 06 - 12 - - - - - - - - - - - - - - - -

MOUNTING POSITIONS:01-06

S = STEEL
A = ALUMINUM

0 = WITHOUT RELIEF VALVE
1 = WITH RELIEF VALVE
2 = RELIEF VALVE READY
3 = VENTING VALVE READY
4 = WITH R.V. AND V.V. READY
5 = WITH R.V. AND V.V.
6 = V.V. READY AND R.V. READY

0 = WITHOUT RELIEF VALVE
1 = 5-55 BAR
2 = 25-110 BAR
3 = 75-250 BAR

0 = WITHOUT RELIEF VALVE
H = HEX. HEAD SCREW K = KNOB C = COVER CAP I = NOT ADJUSTABLE



SEALS
N = BUNA
V = VITON

VENTING VALVE
000 = WITHOUT V.V.
TS2 = NORMALLY OPEN

VENTING VALVE
0 = NO MANUAL OVERRIDE
2 = PUSH AND TWIST
4 = PUSH BOTTON

CONNECTOR TYPE
0 = WITHOUT COIL
C = CAVI / LEADS
D = DIN 43650
G = DEUTSCH DT04-2P
A = AMP JUNIOR

TENSIONE / VOLTAGE
000 = WITHOUT COIL
D12 = 12 VDC
D24 = 24 VDC
D26 = 26 VDC